

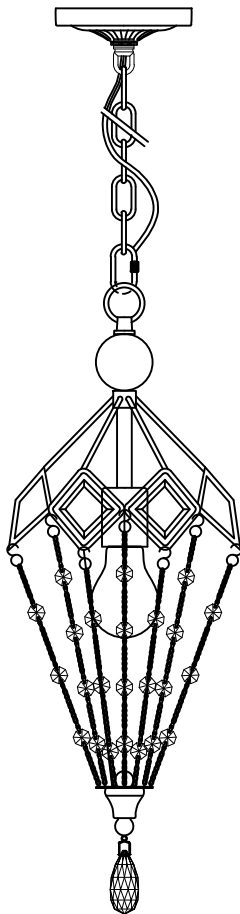

Trade Mark:
CRYSTAL WORLD INC





Product Name: Pendant lamp
Model :9840P8-1-161
120Vac, 60Hz,AC ONLY
Lamp Size:D8"*H21"

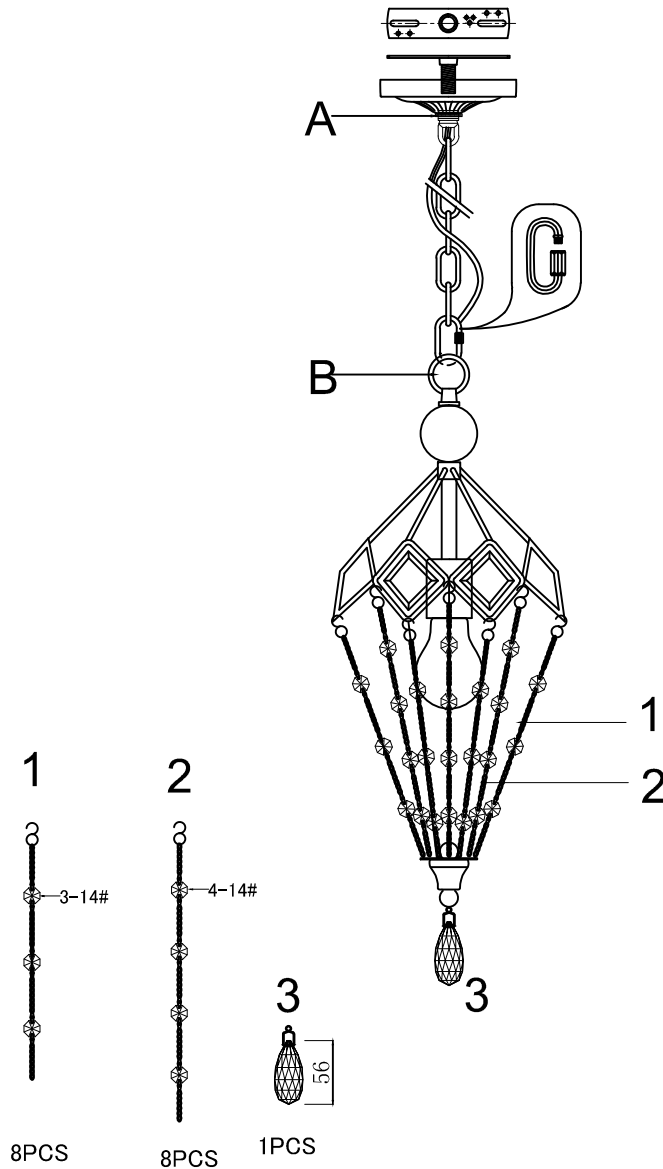

PENDANT LAMP ASSEMBLY INSTRUCTIONS

- 1.Please fix (A) with (B).
- 2.Install bulbs (NOT INCLUDED),USE 120V E26  1*60W Max.



			
40W	56#	14#	-
8PCS	1PCS	56PCS	2300MM