

CWI LIGHTING

BRIGHTER LIVING. SIMPLIFIED.

PROJECT: _____

FIXTURE TYPE: _____

LOCATION: _____

CONTACT/PHONE: _____

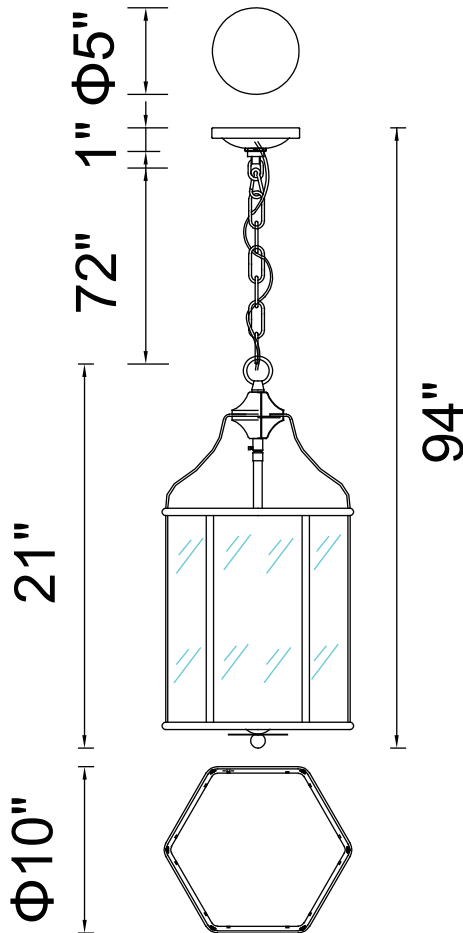

Item	9917P10-3-601
Collection	MAURY
Finish	Chrome
Glass	Clear
Crystal	-----
Input	120V AC,60HZ,AC

Shade	-----
Length/Dia.	10"
Width/Ext.	10"
Height	21"
Maximum	94"
Lumens	-----

Light Source	E12
Bulb Info.	3×60W
Included	-----
Dimmable	No
Color	-----
Weight	